

# Electrothermic carbon microactuator

M. IGNAT\*, G. HRISTEA, P. BUDRUGEAC

National Institute of Electrical Engineering Research –Advanced Research, (INCDIE CA), Micro and Nanoelectrotechnologies, Splaiul Unirii 313, Bucharest Romania

This paper provides the first study of the electrothermic behavior of a carbon material based on formic acid-GIC (formic acid-graphite intercalation compound) and presents some electrothermic micro actuator functional structures.

(Received May 4, 2011, accepted August 10, 2011)

**Keywords:** Actuator, Electro mechanic, Electro thermal, Carbon, Acid-graphite intercalation compound, Displacement

## 1. Introduction

A new division of the micro actuators has been reported [1, 2, 3, 4]: the electro thermally micro-actuators, that can provide both large displacements and forces.

This paper provides the first study of the *electrothermic behavior* of a carbon material based on formic acid-GIC (formic acid-graphite intercalation compound) and presents some electrothermic micro actuator functional structures. These devices are easy to fabrication and could be easily integrated into various electromechanical systems.

Conventionally, exfoliated graphite made from sulfuric acid-GIC has been widely used for the production of flexible graphite as a sealing material at elevated temperatures. The process however has at least two major disadvantages: the intercalation and exfoliation processes cause environmental pollution as they release large amounts of SO<sub>2</sub> and SO<sub>3</sub> and the residual sulfur in the flexible graphite is corrosive during the service. The amount of corrosive residuals in exfoliated GICs can be critical particularly for application in nuclear plants, electronics, aerospace and automotive industries. Considerable efforts have been made to reduce the sulfur contents in exfoliated GICs or to produce sulfur free flexible graphite. In this work we chose formic acid to synthesize GIC electrochemically. Thus, a formic acid-graphite intercalation (*formic acid-GIC*) compound has been successfully synthesized by an electrochemical process whereby formic acid solution serves as both the electrolyte and the intercalate source. The synthesized compounds have been exfoliated by rapid heating to a relatively low temperature (~ 400°C). The exfoliated resulted flakes were pressed into circular plates being studied and modeled in this shape as thermal micro actuators.

This paper provides the first study of the *electrothermic behavior* of a carbon material based on formic acid-GIC. Based on the above mentioned feature has been proposed several possible applications of this material as thermal actuator. In this respect, the micro actuation has been achieved based on dilatation feature of obtained carbon plates.

The paper presents some experimental characteristics for carbon plates proposed as electrothermic micro actuator, such as: displacement function by micro force, temperature range of actuation, electric current and the thermal characterization analysis of this material. Also, are included some theoretical aspects regarding design and modeling of proposed micro actuators, the heat modeling of this micro actuators, electrothermic circuit, diagram of thermal flux propagation, thermal impedance, critical current.

A formic acid-graphite intercalation (*formic acid-GIC*) compound has been successfully synthesized by an electrochemical process whereby formic acid solution serves as both the electrolyte and the intercalate source. The synthesized compounds have been exfoliated by rapid heating to a relatively low temperature (~ 400°C). The exfoliated resulted flakes were pressed into circular plates. This paper provides the first study of the *electrothermic behavior* of a carbon material based on formic acid-GIC. The study has been done on circular plates made from exfoliated formic acid-GIC. Based on the above studied feature has been proposed several possible applications of this material as thermal actuator. To the electrothermic micro actuation, the micro displacement is realized with dilatation of active element (carbon material in this case). The temperature of this actuation is: and displacement field: with a remarkable resolution.

The paper presents some electrothermic micro actuator functional structure, experimental characteristics as; displacement function by micro force, temperature, electric current and the thermal characterization analysis on this material. Other theoretical aspects include the aspects of electrothermic circuit, design micro actuators and modeling: the thermal flux propagation, thermal impedance, critical current.

## 2. The carbon material based on formic acid –GIC

### 2.1. Synthesis of acid formic-GIC

Natural graphite flakes with average flake diameter of 0.4 mm with carbon content of 99.3% were pressed into a

disk of 6 cm in diameter. The disk of graphite served as the working electrode was placed into a platinum gauze. Two platinum plates were employed as the counter electrodes. The Hg/Hg<sub>2</sub>SO<sub>4</sub> 0.615V versus the standard hydrogen electrode (SHE) served as the reference electrode. 100ml of pure HCOOH (98%) was used as electrolyte in the electrochemical process. By using a galvanostat (EG and G Model 273) was applied an anodic current and recorded the reaction potential change with time. An anodic oxidation occurred under a constant current density with a range of 1-20mA cm<sup>2</sup> and the intercalation reaction lasted for 5-10 hours. All experiments were performed in normal conditions. After reaction the graphite were dried in air at 70°C for one hour.

For exfoliation a graduated quartz glass beaker was heated in a furnace to desired temperature. The HCOOH-GIC decomposed and expanded immediately. After 10 s the beaker was removed from the furnace, following by measuring the expanded volume V (ml) and net weight W (g) of exfoliated graphite to obtain the specific expansion volume per gram graphite V/W (ml g<sup>-1</sup>).

The stage structure of reacted graphite was characterized by powder X-ray diffraction with CuK  $\alpha$ ; The microstructure and morphology of exfoliated graphite were examined using a scanning electron microscope. The specific surface area of the exfoliated graphite was measured by nitrogen gas adsorption and Brunauer – Emmett-Teller (BET) calculation in a surface analyzer (Coulter SA 3100).

## 2.2. Characterization of synthesized GICs- based carbon materials

Formation of formic acid-graphite intercalated graphite by an electrochemical reaction is demonstrated by XRD spectra. The (00l) X-ray diffraction patterns (Fig. 1.) show that reacted graphite exhibits the stage structure 3 and 4 with the repeat spacing along the c-axis ( $I_c$ ) of 14.41 and 17.75 Å respectively. The average thickness of the intercalate layer (d1) is identified as 7.71 Å.

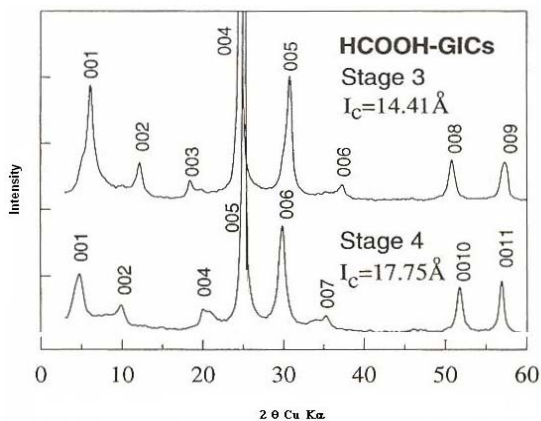

Fig. 1. X-ray diffraction patterns of HCOOH-GICs (non-exfoliated graphite) with stage structure 3 to 4.

The formation of HCOOH-GIC is also demonstrated by the exfoliation of reacted graphite by rapidly heating at 400°C. Exfoliation of HCOOH-GIC flakes produce worm like graphite structures. SEM images (Fig. 2) reveals that are no differences between the exfoliated HCOOH-GIC and conventional exfoliated graphite.

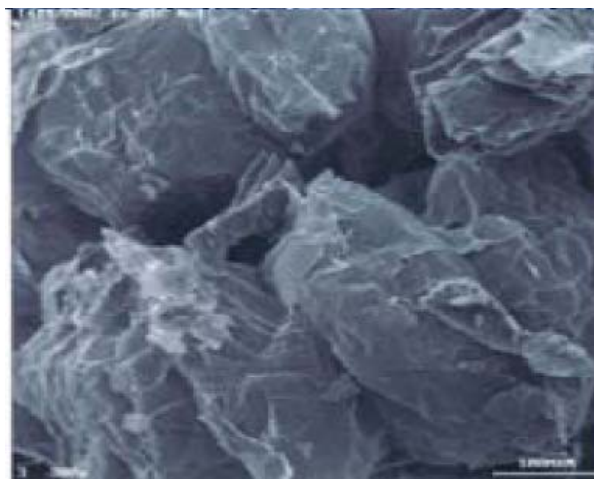

Fig. 2. SEM image of exfoliated HCOOH-GICs.

The expansion volume of 300 ml/g can be achieved by heating at 800°C for 10 seconds. The BET surface area of 20-50 m<sup>2</sup>/g is obtained from the exfoliation of graphite with an expansion volume of 100-300 ml/g.

## 2.3. Thermal analysis of obtained carbon materials

The thermal behavior of obtained carbon plates was examined by simultaneous thermalgravimetry (TG) and dynamic scanning calorimeter (DSC), and dilatometer (DIL). The heating curves (TG and DSC) of sample were simultaneously recorded with STA 409PC apparatus produced by Netzsch – Germany, in static air atmosphere, in the temperature range 20°C – 200°C, and at a heating rate of 10.0 K.min<sup>-1</sup>. The mass of the analyzed sample was 2.2 mg and the heating was performed in a cylinder shape  $\alpha$ -Al<sub>2</sub>O<sub>3</sub> holder. The obtained results are shown in Fig. 3. In the temperature range 20°C – 200°C the weight is constant, and DSC curve exhibits a change of the base-line in the range 57°C – 116°C. The inflexion of DSC curve occurs at 85.8°C, which is the glass transition temperature.

The DIL curve of sample was recorded with dilatometer DIL 402 PC/4 produced by Netzsch – Germany, adapted for volume change measurements, in the temperature range 20°C – 200°C, and at a heating rate of 2.5 K.min<sup>-1</sup>. The obtained results are shown in Fig. 4. A contraction of the sample occurs in the range 20°C – 53.6°C, which is followed by the sample dilatation. The dilatation curve exhibits a change of the base-line in the range 70°C – 116.1°C, characterized by an inflexion at 87.3°C, which is the glass transition temperature.

One notes the very good agreement between the glass transition temperature determined by DSC and DIL measurements.

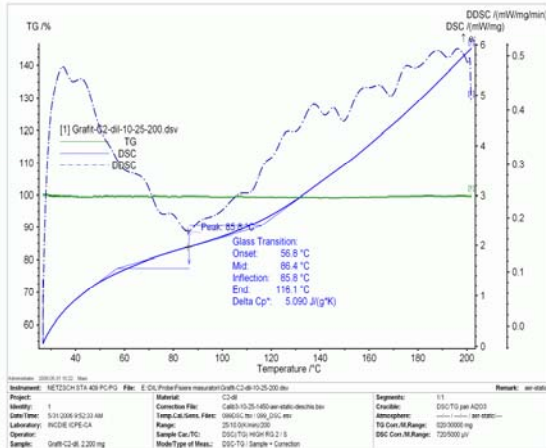

Fig. 3. The TG and DSC curves.

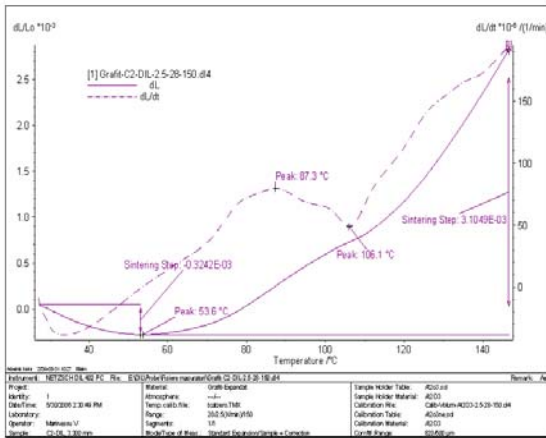

Fig. 4. DIL curve.

2.4 Electrical characteristics

In electro mechanics applications necessary characteristics is the linear or the nonlinear behavior [9]. By the experimental characteristic (Fig. 4) this material can be characterized as a nonlinear behavior.

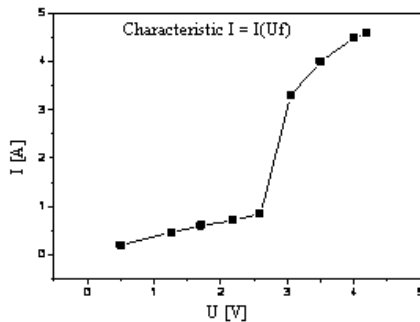

Fig. 5. Characteristic I(U) for carbon material what indicate the electric nonlinearity.

3. The electro thermal micro actuators

3.1 Modeling

Consider a thermal inhomogeneous system [6,7,8 ] with two elements (for the each active electrothermic carbon element see Fig. 6):

I.(c) – connecting cooper strap, and:

II.(elth)- electro thermal carbon element, which is characterized by the following parameters:

$$I\{S_1, s_1, J_1, \rho_1, \lambda_1, \alpha_1, a_1, b_1\}$$

and:

$$II\{S_2, s_2, J_2, \rho_2, \lambda_2, \alpha_2, a_2, b_2\},$$

where ;

$S_{1(2)}$  – transverse section,  $s_{1(2)}$  - transverse perimeter,  $\rho_{1(2)}$  – the electric resistivity,  $\lambda_{1(2)}$ - the thermal conductivity,  $\alpha_{1(2)}$ -the thermal coefficient of the resistivity,  $a_{1(2)}$  and  $b_{1(2)}$ - the electrothermic ratios, that can be expressed as ;

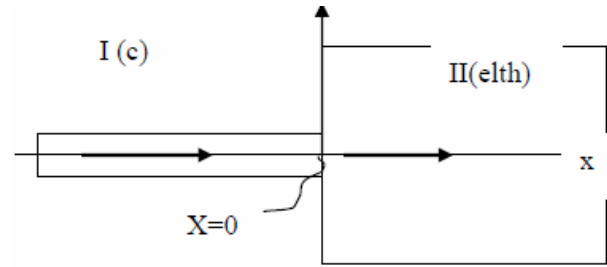

Fig. 6. Modelling of electro thermal micro actuator system.

$$a_1 = \sqrt{\frac{\alpha_1 s_1}{\lambda_1 S_1}}, a_2 = \sqrt{\frac{\alpha_2 s_2}{\lambda_2 S_2}} [m^{-1}] \tag{1}$$

$$b_1 = \sqrt{a_1 \theta_a + \frac{J_1^2 \rho_1}{\lambda_1}} [grad^{0.5} m^{-1}],$$

$$b_2 = \sqrt{a_2 \theta_a + \frac{J_2^2 \rho_2}{\lambda_2}} [grad^{0.5} m^{-1}] \tag{2}$$

with  $\theta_a$  – ambient temperature.

To each system element the thermal stress is defined by the recursive equations [6, 7]:

$$\frac{d^2 \theta_1}{dx^2} - a_1^2 \theta_1 + b_1^2 = 0, \frac{d^2 \theta_2}{dx^2} - a_2^2 \theta_2 + b_2^2 = 0 \tag{3}$$

and we have the solutions:

$$\theta_1(x) = A_1 e^{a_1 x} + B_1 e^{-a_1 x} + \theta_{s1} \tag{4}$$

$$\theta_2(x) = A_2 e^{a_2 x} + B_2 e^{-a_2 x} + \theta_{s2} \tag{5}$$

with the particular solutions:

$$\theta_{s1} = \frac{b_1^2}{a_1^2} = \theta_{a1} + \frac{J_1^2 \rho_1 S_1}{\alpha_1 s_1} \quad (6)$$

$$\theta_{s2} = \frac{b_2^2}{a_2^2} = \theta_{a2} + \frac{J_2^2 \rho_2 S_2}{\alpha_2 s_2} \quad (7)$$

These solutions represent the stationary temperature state on the electrothermic electric current effect in the absence of the axial heat change.

For the determination of the  $A_1, B_1, A_2, B_2$  constants we consider the frontier conditions:

$$x = -\infty, \theta_1(-\infty) = \theta_{s1}, \left( \frac{d\theta_1}{dx_1} \right)_{x=-\infty} = 0 \quad (8)$$

$$x = 0, \theta_1(0) = \theta_2(0) = \theta_d, \left( \frac{d\theta_1}{dx} \right)_{x=0} = \left( \frac{d\theta_2}{dx} \right)_{x=0} \quad (9)$$

$$x = +\infty, \theta_2(+\infty) = \theta_{s2}, \left( \frac{d\theta_2}{dx} \right)_{x=+\infty} = 0 \quad (10)$$

By the condition (8),  $B_1 = 0$  and the solution (4) is:

$$\theta_1(x) = A_1 e^{a_1 x} + \theta_{s1} \quad (11)$$

From (9) in section between sub domains I and II (see Figure 6):

$$\theta_d = A_1 + \theta_{s1} \quad (12)$$

And:

$$A_1 = \theta_d - \theta_{s1} \quad (13)$$

So results;

$$\theta_1(x) = (\theta_d - \theta_{s1}) e^{a_1 x} + \theta_{s1} \quad (14)$$

Similar

$$\theta_2(x) = (\theta_d - \theta_{s2}) e^{a_2 x} + \theta_{s2} \quad (15)$$

From (9) to  $x = 0$  is possible to determine  $\theta_d$  ;

$$a_1(\theta_d - \theta_{s1}) = -a_2(\theta_d - \theta_{s2}) \quad (16)$$

$$\theta_d = \frac{a_1 \theta_{s1} + a_2 \theta_{s2}}{a_1 + a_2} \quad (17)$$

In the Table 1 is presented a numerical cover example (specific of the microstructure of electrothermic actuator presented in Fig. 7).

Table 1. The dimensions of the electrothermic actuator variants.

L [mm]	l <sub>c</sub> [mm]	d <sub>c</sub> [mm]	d [mm]	g <sub>c</sub> [mm]	g <sub>s</sub> [mm]
49	13	5	12	0.5	1.16
100	25	5	10	0.5	1
3-20	4	4	4	0.5	1

### 3.2 Microstructures of the electrothermic micro actuators

In Fig. 7 is presented the first electrothermic experimental micro actuator structure where the carbon active element (with grey color) is fixed on the glass support and in Table 1 are listed the three experimental variants where  $g_c$  - represented the thickness of the carbon element and  $g_s$  - the thickness of glass support with square geometry.

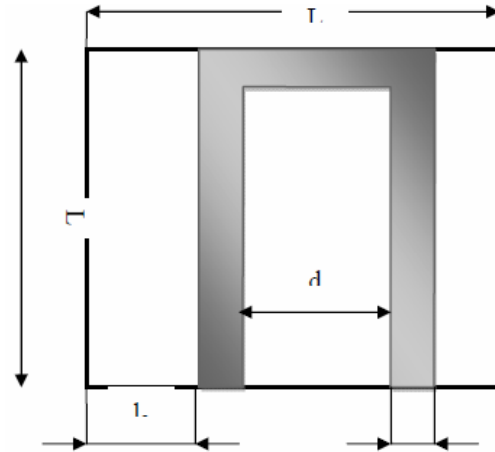

Fig. 7. Microstructure of one electro thermal actuator.

Another microstructure is presented in Fig. 8 where active carbon element (2) of the electro thermal micro actuator are mounted on the glass support (1), with the connection between the carbon element are realized with copper strap (3) with width 2mm, thickness 0,1 mm and the external connection (4). The carbon elements have a square geometry with 5 mm side and glass support has also a square geometry Fig. 7. Microstructure of one electro thermal actuator.

The thickness of the carbon element is 0,5 mm, width is 5mm and the thickness of glass support is 1 mm. In Figure 8 is presented a micro actuator with spiral geometry of the carbon element (breath 2 mm, the thickness 0,5mm and the distance between sides of spiral 1mm).

	I(c) Sub domain micro actuator cooper strap	II(eth) sub-domain micro-actuator carbon element
Transverse section $S_1 [m^2]$	$S_1 = 0,1 \cdot 10^{-3} \cdot 2 \cdot 10^{-3} = 0,2 \cdot 10^{-6}$	$S_2 = 0,5 \cdot 10^{-3} \cdot 5 \cdot 10^{-3} = 2,5 \cdot 10^{-6}$
Transverse perimeter $s_1 [m]$	$s_1 = 4,2 \cdot 10^{-3}$	$s_2 = 11 \cdot 10^{-3}$
Resistivity $\rho [\Omega m]$	$\rho_1 = 0,00158 \cdot 10^{-6}$	$\rho_2 \cong 14 \cdot 10^{-6}$
Thermal conductivity $\lambda [W \cdot m^{-1} \text{grd}^{-1}]$	$\lambda_1 = 390$	$\lambda_2 \cong 120$
Thermal coefficient of the resistivity $\alpha' [\text{grd}^{-1}]$	$\alpha'_1 = 0,0043$	$\alpha'_2 = 0,0013$
Electric current density $J [A/m^2]$	$J_1 = 225 \cdot 10^{-3}$ (to $I = 45 \cdot 10^{-3} [A]$ )	$J_2 = 18 \cdot 10^{-3}$
Electrothermic ratio $a [m^{-1}]$	$a_1 = 0,481175$	$a_2 = 0,2183$
Electrothermic ratio $b [\text{grd}^{0,5} m^{-1}]$	$b_1 = 390$	$b_2 = 2,089$
Environment temperature $\theta_a [^{\circ}C]$	$\theta_a = 20$	$\theta_a = 20$
Particular solutions to extreme heat stress $\theta_s [^{\circ}C]$	$\theta_{s1} = 41,5$	$\theta_{s2} = 91,57$
Temperature to the $x=0$ $\theta_d [^{\circ}C]$	$\theta_d = 57,1$	$\theta_d = 57,1$

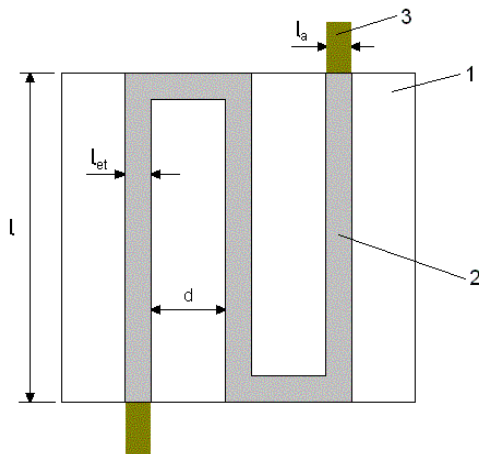

Fig. 8. Structure of electro thermal actuator spiral.

The carbon spiral element is mounted on a glass support with 10 mm side.

#### 4. Experiments

Two heating characteristics by the electric current of the micro actuator (with structure presented in Fig. 6 are showed in Fig. 9 with two domain ; a) 0 -17 mA and b) 12 mA – 37 mA and represents the functional field of electro thermal actuation. In characteristics b) between 25 mA and 37 mA, is evidenced a distinct field with a gradient  $\sim 2,083 [^{\circ}C/mA]$ .

Specific experimental electro mechanic characteristic; displacement function electric current is presented in Fig. 10. with a displacement gradient of  $1,666 [\mu m/mA]$  in sub domain  $25 \div 37 mA$ , which can be considered the optimum functional sub domain.

An experimental characteristic of the responding time indicates 125 sec. (See Fig. 11).

The experiment was realized to a constant force: 2,5N.

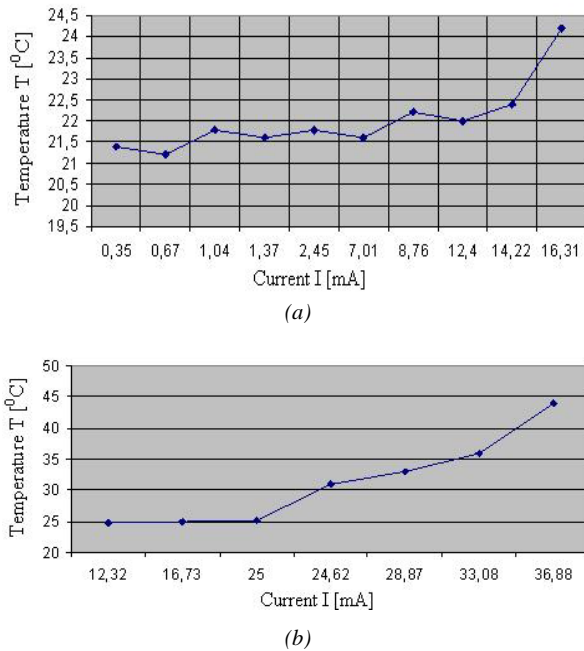

Fig. 9. The experimentally dependence of temperature on electric current.

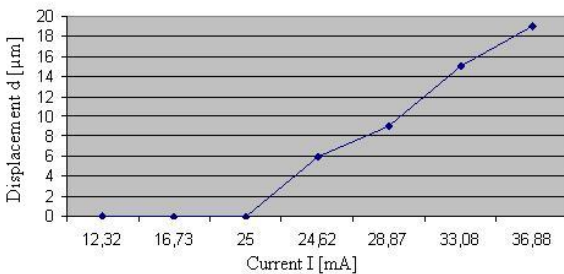

Fig. 10. Characteristic of displacement for micro actuator.

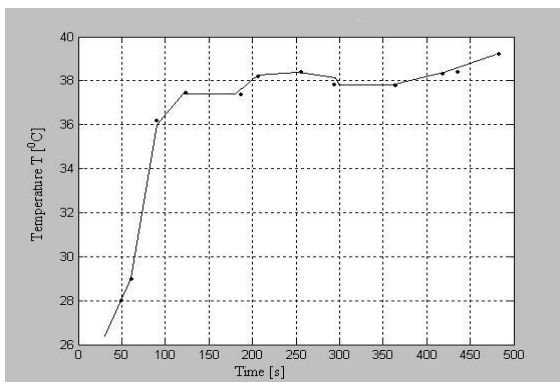

Fig. 11. Characteristics of experimental response time.

## 5. Conclusions

In the paper are presented some electro thermal micro actuators with a carbon material based on formic acid-GIC (formic acid-graphite intercalation compound). This type of micro actuator has a small temperature field  $25 - 40^{\circ}\text{C}$  (which not introduce the heating problems in applications) and very small field of current; max.38 mA. Another important parameter in applications are the gradient or the sensibility:  $1,66[\mu\text{m}/\text{mA}]$ .

The authors present the first result of researches of the one of presented structure (see Figure 7). This actuators category of thermal actuators is a rarely approached in this moment.

## Acknowledgments

This work has been supported by the financial support of the nucleus ANCS Romanian authority, project no. PN 0935-0.01/2009.

## References

- [1] E. T. Carlen, C. H. Mastrangelo, IEEE Journal of Micro electro mechanical Systems **11**(3), 165 (2002).
- [2] W. Riethmulle, E. Beneccke, A. Heuberger, Dig. Int. Conf. Solid State Sensors and Actuators, Tokyo, June, 834, 1987.
- [3] P. L. Bergstrom, Y. Liu, M. Kaviani, K. Wise, IEEE Journal of Micro electromechanical Systems **4**, March, 10 (1995).
- [4] M. Ignat, G. Hristea, G. Telipan, Unconventional Electromechanic Actuators and Sensors, Ed. Electra, 2004.
- [5] C. I. Mocanu, Theory of the electric circuits, Ed. Didactica si pedagogica, Buc. 1979.
- [6] Gh. Hortopan, Aparate electrice, Ed. Didactica si pedagogica, Bucuresti, 1980.
- [7] I. Suci, Bazele calcului solictarilor termice ale aparatelor electrice, Ed. Tehnica, Bucuresti, 1980.
- [8] A. Bach, Uber die Erwarmung des n-Korper Systems, Arch. Electrotech., 1933.

\*Corresponding author: [mignat@icpe-ca.ro](mailto:mignat@icpe-ca.ro)