

Nanophotonics for efficient photovoltaic solar cells

J. J. SIMON*, F. FLORY^a, L. ESCOUBAS, P. TORCHIO, YU-JEN CHEN, D. DUCHÉ

Paul Cézanne University, IM2NP UMR6242, Marseille, France

Domaine U. de St Jérôme, 1397 Marseille cedex 20, France

^aEcole Centrale Marseille

This paper deals with the improvement of "light harvesting" in photovoltaic cells by using three photonic concepts. First, we theoretically demonstrate that an improved absorption can be obtained in nanostructured P3HT/PCBM thin films by using a photonic crystal structure. Then, plasmonic phenomenon inside an organic solar cell based on a photoactive MEH-PPV:PCBM bulk heterojunction is studied using FDTD numerical modelizations and compared with experimental results. Finally, a new model is presented which takes into account quantum confinement and classical theory to determine the complex refractive index wavelength dispersion in optical materials including quantum dots.

(Received December 15, 2009; accepted January 20, 2010)

Keywords: Photovoltaics, Solar cell, Nanophotonics

1. Introduction

Among the variety of renewable energies, photovoltaic is a proven technology. Today silicon is still the leading technology in the world market of photovoltaic solar cells, with power conversion efficiencies reaching 25% for mono-crystalline devices. Although solar radiation is ideal to meet the projected demand, solar energy conversion requires new methodologies to harvest incident photons with greater efficiency and economical viability. Progresses are expected to increase the efficiency and to reduce the cost of solar cells which are still mainly based on bulk silicon. In order to overcome these problem different ways are investigated like the use of thin films with different materials: amorphous silicon, organics, or CIGS. One other major challenge in achieving high efficiency thin film solar cells is the insufficient absorption of long wavelength photons because of the low absorption coefficient and short optical path length imposed by the small film thickness.

The aim of this paper is to demonstrate how photonics can improve photovoltaic conversion in thin film solar cells by means of:

- photonic crystals (PC) concept and slow Bloch modes properties
- plasmonic excitation using metallic nanoparticles (NPs)
- quantum confinement of electrons and holes in nanocrystals.

2. Photonic crystals for enhancing the absorption of light in organic solar cells (OSC):

There is a fundamental difference between solar cells based on inorganic or on organic semiconductors. In solar

cells made from inorganic semiconductors, photons are directly converted at room temperature into free charge carriers (electrons and holes) which can be collected at their respective electrodes. In OSC, a photon absorption leads to the creation of a bound electron hole pair called exciton, which binding energies are ranging from 50 meV up to >1 eV [1]. Then, excitons have to diffuse to be dissociated into free charges. This additional stage of excitons diffusion completely changes the scale of the physical phenomenon involved in OSC. Indeed, in silicon photovoltaic technology, the electron diffusion length could reach the wafer thickness ($>200\mu\text{m}$) even in polycrystalline silicon. In organic materials, both the exciton diffusion length and the charge carrier diffusion lengths are in submicrometric range (10-20nm for excitons and 100-200nm for charge carriers). The most visible consequence of such low values is the design of the organic photovoltaic devices where the active layer thicknesses do not exceed 200 nm [2]. Furthermore, polymer /PCBM bulk heterojunctions exhibit very low absorption in the near infra-red ($\lambda > 600$ nm). The key solution is to enhance the optical path length by strongly trapping light within the cell. In the following we will theoretically demonstrate that the absorption of light can be strongly enhanced in P3HT/PCBM organic thin films, nano-structured in the form of specific photonic crystals [3].

A schematic view of the structure of interest, which can be considered as a photonic crystal, is depicted in Fig. 1. It is composed of a squared matrix of poly(3-hexylthiophene) (P3HT) (donor) nanowires embedded in a fullerene derivative (6,6)-phenyl-C61-butyric-acid-methylester) PCBM (acceptor).

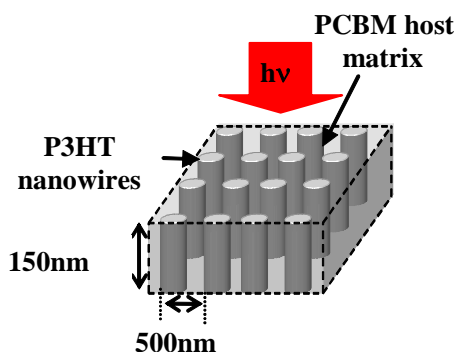

Fig. 1. P3HT/PCBM nanostructured in the form of a photonic crystal. Ordered heterojunction composed of P3HT nanowires embedded in PCBM.

The photonic band diagram of this structure is computed using the Finite Difference Time Domain (FDTD) method. The goal is to design this P3HT/PCBM photonic crystal in order to allow slow Bloch modes coupling. Slow Bloch modes are Bloch modes having a long lifetime inside the photonic crystal and are located at an extremum of a flat dispersion curve in the band diagram (in the Γ direction for light in normal incidence). Figure 2 shows a comparison of the light absorption versus the frequency of a standard P3HT:PCBM blend - bulk heterojunction - (1:1 weight ratio) in thin film form and that of the P3HT/PCBM photonic crystal (ordered heterostructure) of Fig. 1, computed by FDTD. With P3HT nanowires length of 50 nm, a diameter of 400 nm and a matrix period of 500 nm the absorption is increased by 35.6% for wavelengths ranging between 600 and 700 nm.

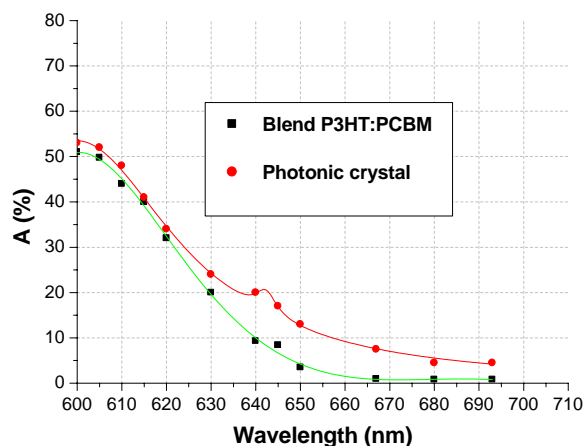

Fig. 2. P3HT:PCBM blend (bulk heterostructure) absorption compared to P3HT/PCBM photonic crystal (ordered heterostructure) absorption.

To summarize, we theoretically demonstrate that an improved absorption can be obtained in nanostructured

P3HT/PCBM thin films by using a photonic crystal structure. Furthermore, the shape of the P3HT/PCBM photonic crystal presented in this paper may also improve the charge transport properties of these materials by creating percolation pathways.

3. Improving light absorption in organic solar cells by plasmonic contribution:

A surface plasmon is an optically generated wave which propagates along a metal/dielectric interface. By tuning the light excitation, a resonance can occur when the frequency of the incident photons equals the collective oscillation frequency of conduction electrons of metallic particles. In photonics, this domain is known under the appellation “plasmonics” and has been already successfully applied for silicon solar cells [4,5]. The work presented in this paper aims at studying the potentiality of this plasmonic technique on organic cells by comparing the spectrophotometric measurements of an interpenetrated donor-acceptor blend layer with FDTD modelling [6]. Photoactive layers were fabricated from an interpenetrated network of conjugated polymer poly(2-methoxy-5-(2-ethyl-hexyloxy)-1,4-phenylenevinylene) (MEH-PPV) as electron donor and PCBM as electron acceptor. These layers were deposited on silica substrates, after the incorporation of silver nanoparticles in some of the samples. The values of absorbance (A) and scattering (S) of these samples in the visible range (figure 3) were deduced from spectrophotometric measurements of the reflectance (R) and the transmittance (T) ($A+S = 1-R-T$). We clearly observe an improvement of $(1-R-T)$ over a broad spectral range from 375 up to 800 nm which can be mainly attributed, in the 375-575 nm region, to a plasmonic effect inside the heterojunction. Moreover, we modeled previous structures with a simplified design constituted of a two-dimensional (2D) array of silver nanospheres having a 40 nm diameter.

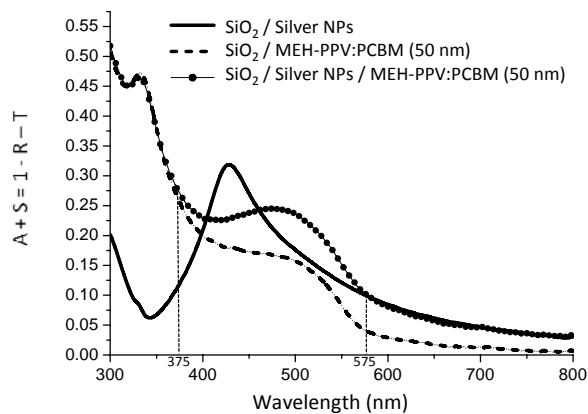

Fig. 3. Values of $A + S = 1 - R - T$ deduced from spectrophotometric measurement of reflectance and transmittance for the devices: silica / silver nanoparticles (solid line), silica / MEH-PPV:PCBM 1:4 without (dotted line) or with silver nanoparticles (filled circles line).

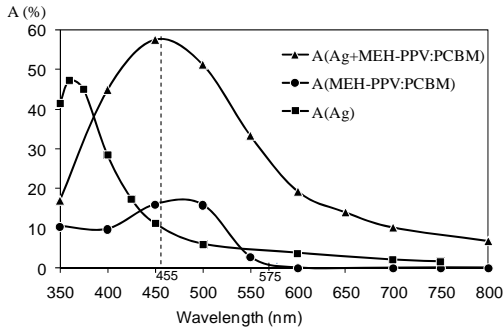

Fig. 4. Calculated values of absorptance $A = (1-R-T)$ versus wavelength for devices: silver nanoparticles in the air (■), MEH-PPV:PCBM alone (●), and silver nanoparticles embedded in MEH-PPV:PCBM (▲) showing a resonance at $\lambda = 455$ nm.

In Fig. 4, calculated values of absorptance versus wavelength, are presented for a squared 2D-grating of silver nanoparticles placed in the air, for the MEH-PPV:PCBM interpenetrating network alone, and for silver nanoparticles embedded in the network. We observe an enhancement of the absorptance on a large spectral range ($350 \text{ nm} < \lambda < 800 \text{ nm}$) for samples consisting in a blend including NPs in comparison with those without NPs. We can also notice that the plasmon resonance wavelength is redshifted by 95 nm from $\lambda = 360 \text{ nm}$ to $\lambda = 455 \text{ nm}$ according to the Mie Theory.

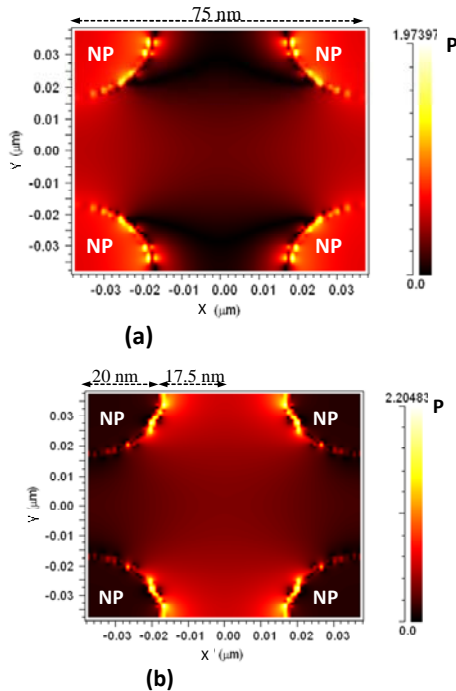

Fig. 5. Spatial distribution of the P power density of the electromagnetic plane in the nanoparticles plane $\{x, y\}$ and in the dielectric vicinity of an array of 4 silver NPs at the incident wavelength of: (a) 450 nm, (b) 600 nm.

To separate the contributions of the absorptance in the metallic nanospheres to that in the bulk heterojunction we have calculated the distribution map of the power density (P) carried by the electromagnetic plane wave in our plasmonic structure (figure 5). We locally observe a very strong increase of the power density at the interface between the blend and the NPs ("bright areas") and a non-negligible level inside the NPs showing that silver absorbs a part of the incident light at $\lambda = 450 \text{ nm}$. In summary, we demonstrated an absorption enhancement induced by silver nanoparticles within a dielectric layer. A benefit of this localized surface plasmons on absorption could be used to increase photovoltaic power efficiency of OSC.

4. Quantum confinement of electrons and holes in nanocrystals

Another very promising way to increase the solar cell efficiency is to use nanocrystals to convert light frequency. Indeed only part of the solar spectrum is useful for active materials. In particular both short wavelengths (UV) and long wavelengths (IR) do not induce efficient photovoltaic effect. If the nanocrystal is luminescent, UV can be changed in visible wavelengths (down conversion). If two IR photons are involved in the process, visible light can also be obtained (up conversion). In this case of quantum dots nanocrystals, obviously the frequency conversion is based on quantum confinement. It is necessary to predict the refractive index of such layers including quantum dots to be able to optimize the optical properties of photonic components. The optical properties of nanostructured thin film have been studied for many years [8]. In most of the nanostructures, rigorous electromagnetic theory can be efficiently used to describe light propagation but, once the structure size is of a few nanometers, quantum theory has to be considered. As an example, the size dependant luminescent behaviour of some nanocrystals is due to quantum confinement. Our new model takes into account quantum confinement and classical theory to give the complex refractive index wavelength dispersion in optical materials including quantum dots.

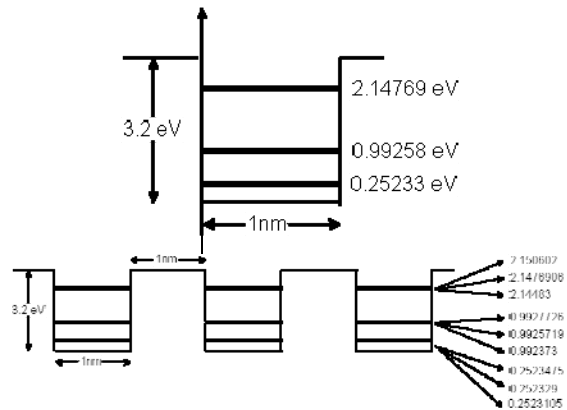

Fig. 6. Energy levels for electrons in a single well and in 3 wells separated of 1nm, of 1nm width and of a depth of 3.2 eV

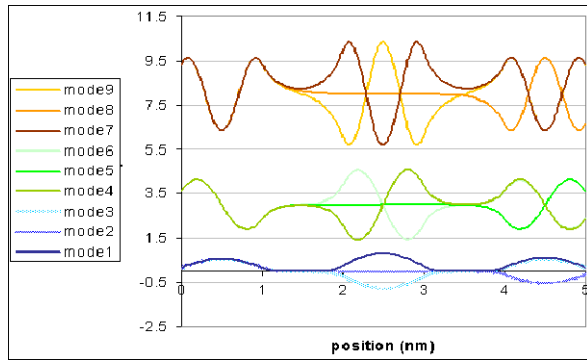

Fig. 7. Wave function distribution for electrons in 3 wells separated of 1nm, of 1nm width and of a depth of 3.2 eV

We implement a calculation to study the energy quantization of the electrons and their wave function distribution in the material. We start with a 1D model which considers quantum wells. From Schrödinger equation it can be shown [9] that the equation giving the energy levels in a single quantum well is very similar to that of a planar waveguides [10], the electron wave function Ψ taking place of the electric field. As for multilayer planar waveguides, this formalism can be extended to multiple quantum wells. Thanks to the continuity of Ψ and its derivative with the coordinate perpendicular to the well boundaries $\frac{d\Psi}{dx}$, a recurrent relation can be founded for $\Psi / \frac{d\Psi}{dx}$ which is similar to the

recurrent relation for the optical admittance in multilayer waveguides. If the electron is confined in the well, Ψ is evanescent in the surrounding media like the electric field is evanescent in the media surrounding a waveguide. The equation describing the possible discrete energy levels is then derived from these considerations. For a single quantum well, analytic values can be obtained [11] and our calculation results are in agreement with them. It is interesting to consider several coupled quantum wells. We have shown that each energy level is degenerated in a number equals to the number of coupled identical quantum wells. An example of possible energy levels is given in Figure 6 for a single well and for 3 wells separated by 1nm, of 1nm width and of an energy of 3.2 eV corresponding to TiO_2 nanocrystals in SiO_2 . Figure 7 shows the wave function distributions in the 3 coupled wells. We continue studying how the energy levels change with different parameters: size of single quantum wells, number of coupled quantum wells, distance of coupling, size distribution of coupled quantum wells. The spectral absorption can be derived from the energy levels and then

the extinction coefficient wavelength dispersion. Kramer-Krönigs relations can then be used to obtain the wavelength dispersion of the real part of the refractive index $n(\lambda)$. We will study how $n(\lambda)$ can be modified by changing the size of nanoparticles. Layers including quantum dots are under realization and measured absorption and $n(\lambda)$ will be compared to calculated ones.

5. Conclusion

In this paper we demonstrated the improvement of “light harvesting” in photovoltaic cells by using photonic nanostructures. Three different concepts have been presented: photonic crystals, plasmons and quantum confinement. If it is obvious that new materials are needed to push up the efficiencies of solar cells, developing new optical concepts might be one promising way for solar cells development.

References

- [1] B. A. Gregg, J. Phys. Chem. B, **107**(20), 4688 (2003)
- [2] F. Monestier, J.-J. Simon, Ph. Torchio, L. Escoubas, F. Flory, S. Bailly, R. De Bettignies, S. Guillerez, C. Defranoux, Sol. Energy Mater. Sol. Cells **91**, 405 (2007).
- [3] D. Duché, L. Escoubas, J. J. Simon, Ph. Torchio, W. Vervisch, F. Flory, Appl. Phys. Lett. **92**, 193310 (2008).
- [4] D. Derkacs, S. H. Lim, P. Matheu, W. Mar, E. T. Yu, Appl. Phys. Lett. **89**, 093103 (2006).
- [5] S. Pillai, K. R. Catchpole, T. Trupke, M. A. Green, J. of Appl. Phys. **101**, 093105 (2007).
- [6] D. Duché, Ph. Torchio, L. Escoubas, F. Monestier, J.J. Simon, F. Flory, G. Mathian, Sol. Energy Mater. Sol. Cells **93**, 1377 (2009).
- [7] A. P. Alivisatos, Science **271**, 933 (1996).
- [8] S. V. Gaponenko, Optical Properties of Semiconductor Nanocrystals, Cambridge University Press, Cambridge,(1998).
- [9] C. Cohen-Tannoudji, B. Diu, F. Laloë, Mécanique quantique ,Edit. Hermann, Paris (1977).
- [10] J. Massaneda, F. Flory, E. Pelletier, Appl. Opt Vol. **38**(19), 4177 (1999)
- [11] Robert Eisberg, Robert Resnick, Physics of atoms, molecules, solids, nuclein and particles, 2nd edition, John Wiley and Sons, Appendix H (1985).

*Corresponding author: jean-jacques.simon@univ-cezanne.fr