

# Technologies of slow light generation in optical fibers based on Stimulated Brillouin Scattering

ZHAO YONG\*, HUANG HE, WANG QI, QI ZIXIN

Northeastern University, College of Information Science and Engineering, Shenyang, 110004, China

Recently, more and more fiber structures have been proposed and developed to generate slow light. The technology of slow light attracts experts and scholars' much more attentions because of its potential application foreground. Among all the methods of generating slow light, one of the hottest technologies is to generate slow light in fiber based on stimulated Brillouin scattering (SBS), which is also a simplest and most applicable method. In this paper, slow light generation methods based on SBS with monochromatic pump, modulated pump and multiple pumps are introduced and compared. Advantages and disadvantages of all the above methods have been discussed too.

(Received May 31, 2010; accepted July 14, 2010)

**Keywords:** Slow light; Optical Fiber; Stimulated Brillouin Scattering; Pump Wave

## 1. Introduction

Slow light generation has been achieved in many different systems and most of the systems are based on exotic media, such as ultracold atoms [1,2] or planar photonic crystal microcavity arrays [3]. When the slow light was first generated in optical fiber by stimulated Brillouin-scattering, it has been attracting researchers' attentions. More and more experts and scholars get interested in this way to get slow light, because the SBS is a simple and highly efficient method; moreover, the configuration to generate slow light is also flexible.

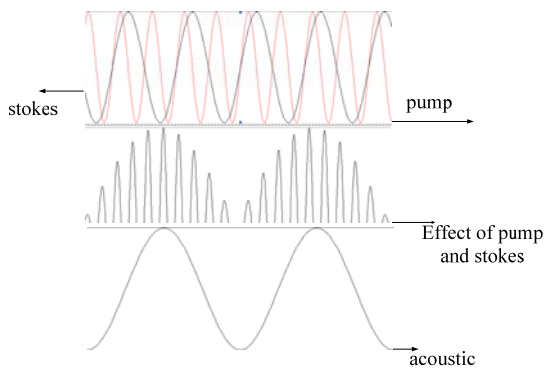

Fig.1 The process of SBS

From Fig.1 the process of SBS can be described as the interaction of two counter propagating waves, that is, the strong pump wave and the weak stokes wave. If this condition matches the equation  $f_{pump} = f_{stokes} + \nu_B$ , where,  $f_{pump}$  is the frequency of the pump wave,

$f_{stokes}$  is the frequency of the stokes wave and  $\nu_B$  is the Brillouin shift, an acoustic wave will be generated which scatters photons from the pump to the stokes wave. SBS can be regarded as a narrowband amplification process.

When a pump wave with high-energy passes through a medium (such as optical fibers), it will lose some energy due to the density change of the medium. So, it changes into lower frequency stokes wave. This process is an unelasticity collide. Recently, many experiments have been carried out to prove the possibility to achieve a controlled wide group delay in optical fibers in the way of the stimulated Brillouin scattering effect.

This paper divides the way to get slow light by SBS into three different kinds according to the different pumps adopted in the system: the first one is with "monochromatic pump", the second one is with "modulated pump" and the last one is with "double pumps". In each part, detailed information of the principles, structures and results are described. At the end of this paper, some new technologies and methods to improve the performances of the slow light generation system based on SBS are also introduced briefly.

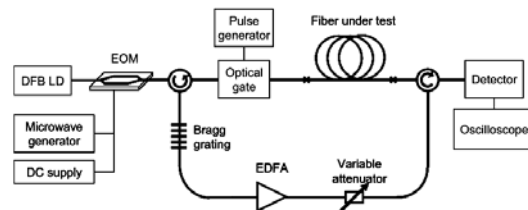

Fig.2. Configuration to measure variable pulse delay from SBS in an optical fiber

## 2. Slow light generation with monochromatic pump

Slow light production in room-temperature with single optical fiber by way of SBS was first proposed by K. Y. Song in 2005[4]. The schematic diagram is shown in Fig.2. In this structure, the DFB laser is a light source with the wavelength of 1552nm. When the light passes through the electro-optic modulator (EOM) controlled by DC supply, two kinds of light are generated. One is the lower sideband, and the other is the upper sideband. The frequency difference between the two lights equals to Brillouin shift of the test fiber. When the two kinds of light with different frequency reach the Bragg grating, the lower sideband is reflected by it. The optical gate controlled by a pulse generator is used to change the reflected lower sideband into stokes wave with the Full Width at Half Maximum (FWHM) of 100ns. Meanwhile, the upper sideband is transmitted and changed into pump wave after being amplified by an EDFA and a variable attenuator. These two kinds of light interfere with each other in the under test fiber. The time delay can be observed in the oscilloscope.

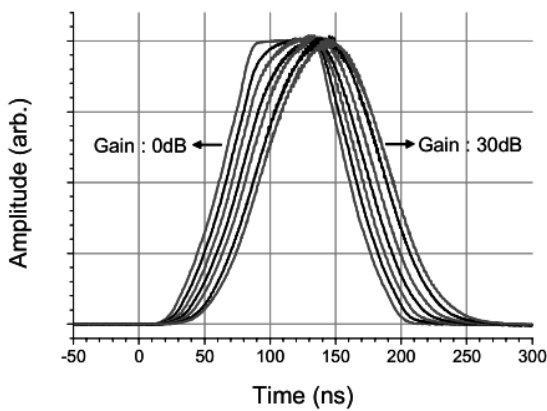

Fig.3 Traces of the probe pulses of different Brillouin gains for standard fiber

Fig. 3 shows the delay time of the pulse as the function of the Brillouin gain in the standard fiber. The pulse with the FWHM 100ns delay 30 ns when the Brillouin gain is 30 dB (The achievable gain is limited to 30 dB due to the spontaneous Brillouin scattering generated with the increasing pump power.)

This is the first time to generate slow light in optical fiber by SBS. The time delay could be changed by adjusting the pump power, and the pulse wavelength could be altered according to the pump wavelength. There are, however, several disadvantages for this method. Firstly, the narrow Brillouin gain and the scope of the wavelength are limited; secondly, the pulse has been stretched. Actually, the main trouble of this method is the Brillouin bandwidth limitation [5].

In the same year, Yoshitomo Okawachi also set up an experiment. Compared with the above method, this method got the Stokes shift wave from SBS generator. Two kinds of pulses were used in the system. One of the pulses was with a width of 63ns and the other was 15ns. At last, the delay times of 25ns and 20ns were obtained separately [6]. The structure of this method is simple due to the less devices used in the experiment.

## 3. Slow light generation with modulated pump

According to the theory, the time delay and spectrum distortion are opposed to each other. Longer time delays lead to bigger spectrum distortion. For this reason, modulated pump was designed to overcome this problem. The basic principle of this technology is to transform the pulse of pump directly.

### 3.1 Method of phase modulation

In Avi Zadok's experiment, the delays increase 30-40% by the way of using synthesized pump chirp (combination of a deterministic, periodic current modulation together with a small random component) to get spectrum with sharp edges which lead to stronger gradients phase response and get longer delays [7]. The experiment structure and results are shown as in Fig.4.

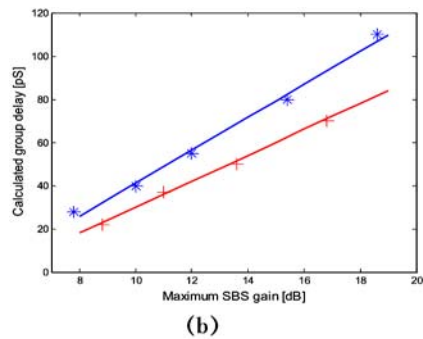
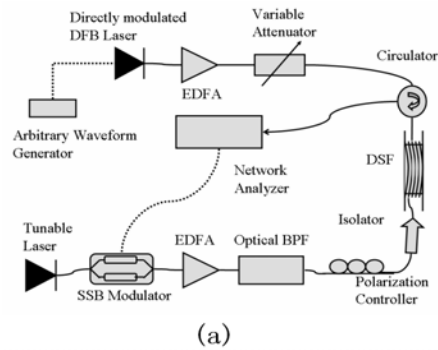

Fig.4 (a) The experiment structure (b) Calculated group delays as a function of maximum SBS power gain, using synthesized (asterisk signs) and random (plus signs) direct pump modulation.

In Fig.4 (a), the pump wave is generated from the DFB laser which is modulated by the voltage of an arbitrary waveform generator directly. Then the pump wave is amplified by an EDFA and a variable attenuator. A circulator directs the pump wave into a dispersion shifted fiber (DSF) with the length of 2km. The tunable laser is used to get stokes wave which is modulated by an SSB modulator. The Vector Network Analyzer is used to detect the beating signal of the carrier and the sideband as reference values to control the SSB modulator. From Fig.4 (b), the group delay is much longer than the random direct pump modulation at the same SBS gain.

### 3.2 Method of amplitude modulation

In 2005, Michael D. Stenner proposed that gain doublet can provide almost twice increase in slow-light pulse delay compared with the optimum single-line delay. The experimental set-up is as shown in Fig.5 [8].

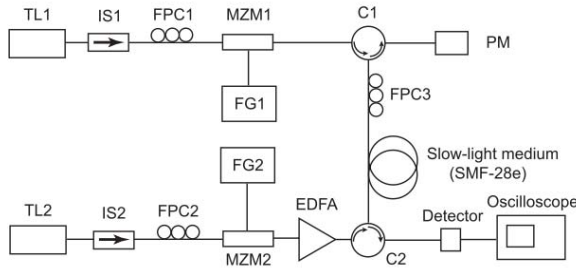

Fig.5 Experiment of low distortion Brillouin slow light in optical fibers using AM modulation

In the Fig.5 (a), the 1550 nm narrow-linewidth tunable laser (TL1) is used to generate stokes wave. The same tunable laser (TL2) modulated by MZM2 is used to get pump wave. The pump wave is amplified by an EDFA and is directed into the single mode fiber (SMF) by a circulator. MZM2 is driven by a sinusoidal voltage which is generated from FG2. The frequency difference between TL1 and TL2 is tuned to the pulse carrier frequency in order to set the center of the SBS amplifying resonances precisely. Fiber polarization controllers (FPC1 and FPC2) are used to maximize the transmissions through the Mach-Zehnder modulators, and FPC3 is used to maximize the SBS slow-light delay experienced by the Stokes pulses. The time delay can be observed in the oscilloscope.

In the Fig. 6, the gain doublet has bigger gain exponent and steep phase shift, which lead to longer time delay.

After this, Aldo Minardo researched this method deeply, and set an experiment with three equally spaced Brillouin gain resonances, further increasing the distortion-constrained pulse delay [9].

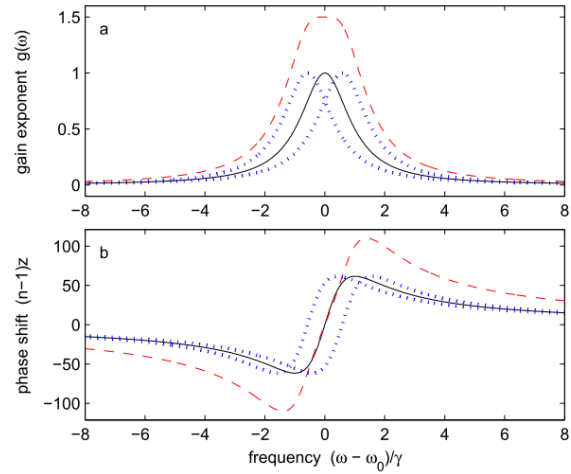

Fig.6 Gain and phase shift of single-line (solid), gain doublet (dashed) and two constituent lines (dotted) that make up the doublet.

### 3.3 Method of frequency modulation

Another method of modulating is to broaden the bandwidth of the pump wave. The Brillouin gain spectrum can be expressed as:

$$g(\Delta\nu) = P(\Delta\nu) \otimes g_B(\Delta\nu) \quad (1)$$

where,  $P(\Delta\nu)$  is the normalized pump power spectral density (so that its integral is unity) and  $g_B(\Delta\nu)$  is the characteristic Lorentzian gain of the Brillouin amplification process, which can be further given by:

$$g_B(\Delta\nu) = g_B \frac{1}{1 - 2j(\Delta\nu / \Delta\nu_B)} \quad (2)$$

where,  $g_B$  is the linear Brillouin gain coefficient,

and  $\Delta\nu_B$  is the characteristic Brillouin width. So the

Brillouin interaction is broadened by adequate pump modulation. When the shape of the pump wave is almost Lorentzian and the Brillouin gain also keeps Lorentzian, the Brillouin interaction width will be equal to the sum of Brillouin gain width and the pump spectral width. According to this principle, Miguel González Herráez got an arbitrary large bandwidth by using a simple and inexpensive pump spectral broadening technology [10].

Based on the theoretical result analyzed by the authors, conclusions may be drawn that the increasing of the pump spectral width can broaden the Brillouin gain. The experiment result is shown as in Fig.7.

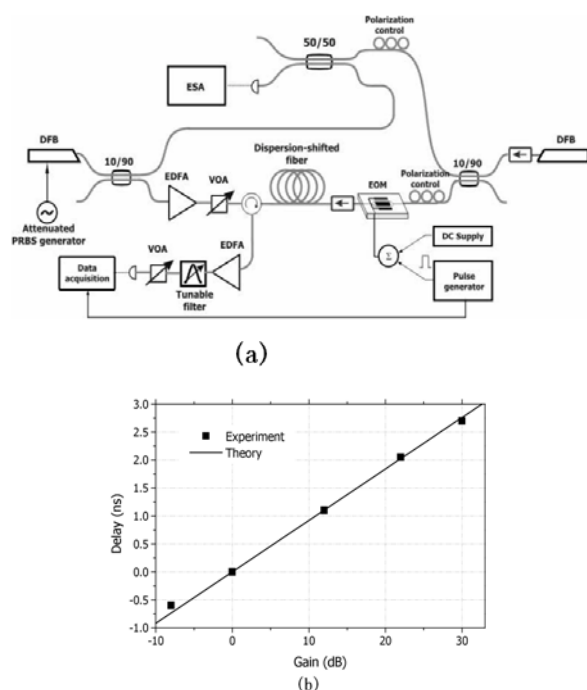

Fig. 7. (a) Experimental setup for broaden the pump spectral (b) the relationship between gain and delay according to the experiment.

In Fig.7 (a), the pump wave is generated from the DFB laser, which is controlled by the attenuated pseudorandom binary sequence (PRBS) generator. The PRBS is used to broaden the pump spectrum by modulating the current of the pump laser. The broad pump wave is amplified by the EDFA and variable optical attenuator (VOA). And the spectrum of the pump is monitored by an electrical spectrum analyzer (ESA). The other DFB laser is used to generate stokes wave, which is modulated by electro-optic modulator (EOM). The pump wave and stokes wave interfere with each other in the dispersion-shifted fiber with the length of 6.7km. The time delay can be recorded by the data acquisition system. In this experiment, the SBS gain spectrum is broadened to 325MHz.

We can see the result from Fig.7 (b), they have shown the delaying of 2.7 ns (The achievable gain is limited to 30 dB due to the spontaneous Brillouin scattering accompany with the increasing of pump power.) with little broadening (<25%).

E. Shumakher also researched pump modulation method to balance the delay and bandwidth and signal distortion with a modulated pump [11]. In 2007, Ronny Henker set an experiment by decoupling the amplifier gain and the time delay. At last, they got the 70ns delays with a simple and feasible way [12]. Kwang Yong Song gave a new method by using anomalous dispersion appearing between two gain peaks, and reduced distortion [13].

From all the methods given above, the ways of using modulated pump can reduce the distortion effectively.

These methods, however, also have disadvantages. For example, The SBS gain spectrum could be broadened up to the point where the Stokes and anti-Stokes bands start to overlap and mutually neutralize. This effect prevents any further extension of the gain linewidth and can be seen as the limit to the practical broadening. However, this problem can be overcome by using double pumps, being introduced as follows.

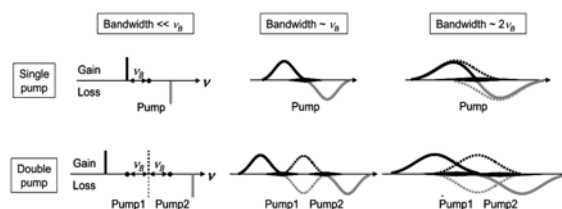

Fig.8 Comparison of gain and loss spectra in single and double Brillouin pumps

#### 4. Slow light generation with double pumps

Another method to avoid the distortion of delaying pulses and limitation bandwidth is using double pumps. The loss spectra of pump 2 is compensated by the gain spectrum of pump 1 which lead to the gain linewidth broaden.

##### 4.1 Double pumps with same power and spectral width

2006, Kwang-Yong Song and Kazuo Hotate designed a structure and got a 25 GHz bandwidth, resulting in a variable time delay up to 10.9 ps with 37 ps pulses [14].

As shown in Fig.8, when the spectral width of the pump is larger than the Brillouin frequency shift, the gain and the loss spectra overlap with each other. When two pumps are selected to be with the same power, and are separated by twice the Brillouin frequency shift exactly. The loss spectrum of pump1 can be compensated by the gain spectrum of pump2 completely. In this way, the bandwidth will increase to 25GHz, twice than usual. The experiment setup is shown as in Fig.9.

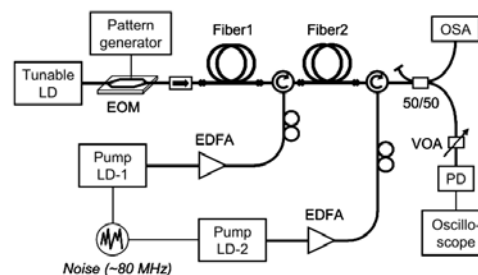

Fig.9 Experimental setup for SBS slow light with double Brillouin pump

Stokes is generated from the tunable LD, which is controlled by an EOM. There are two Brillouin pumps with the same power in this experiment. The two pumps are separated exactly by twice of the Brillouin frequency shift and are broadened identically. Pump1 and pump2 were propagated into the fiber1 and fiber2 separately. Both of the two pumps are amplified by EDFA. The fiber1 is high NA fiber with the length of 2km and fiber2 is dispersion shifted fiber with the length of 6km. Both the fibers have the same Brillouin frequency shift.

In this way, the gain spectrum of pump1 can compensate the loss spectrum of pump2. Therefore, the bandwidth increases to twice of the Brillouin frequency shift.

#### 4.2 Double pumps with different powers and spectral widths

Shihe Wang has researched double Brillouin pumps theory deeply, and constructed the Zero-broadening SBS which was produced by two pump waves with different powers and spectral widths [15]. We can see from Fig.10, the central frequency of stokes gain spectrum of pump1 equals to the anti-stokes loss spectrum of pump2. The

gain spectrum of pump1 just partially compensates the loss spectrum of pump2, then wide gain spectrum with a flat-top is produced. The frequency difference between the two pumps is set equal to the Brillouin frequency shift.

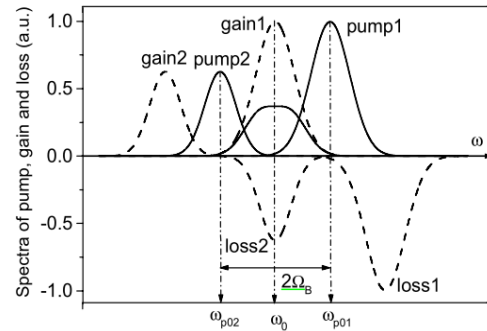

Fig.10 Spectral configuration of double broadband pump beams and the corresponding Brillouin gain as well as loss spectra of them.

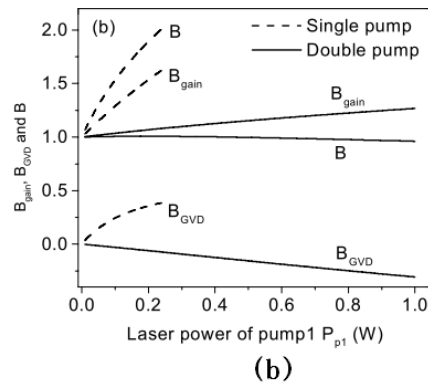
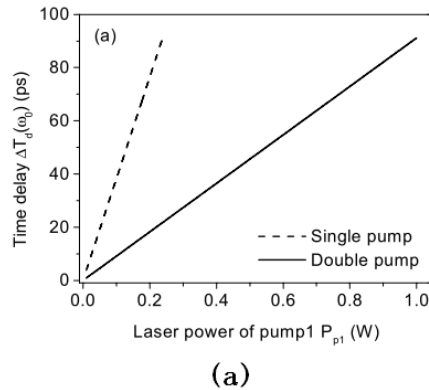

Fig.11 The result of experiment (a) the relationship between time delay and the power of pump1 (b) the relationship between pulse broadening and the power of pump1

From Fig.11(a), the time delay of double pump is smaller than the single pump under the same power of pump1, but from Fig.11(b) we can draw the conclusion that the double pumps system has less pulse broadening than the signal pump system.

## 5. Conclusions

Recently, there are many improved methods to overcome these disadvantages of SBS by using new kinds of optical fiber, such as the chalcogenide fiber [16], the tellurite fiber [17], the bismuth fiber [18], the nano-material doped fiber [19] and so on. Many researches give some special structures to decrease the distortion of

the SBS. Such as Taiji Sakamoto presented a novel method for realizing a slow light with a broadband flat Brillouin gain and low distortion by using an optical frequency comb [20], and César Jauregui designed a cavity modifies to avoid using higher pump powers [21].

In the several ways to generate slow light, the SBS is the most common method. Getting longer delay and less distortion of the spectrum are the purposes of the SBS development. The development speed of this technology is fast. So the slow light generation by SBS will be widely used in many fields in the future, such as data buffering, optical memory, optical signal processing, optical sensing and so on.

### Acknowledgments

This work was supported by the Fundamental Research Funds for the Central Universities (No. 090504002) , and the Program for New Century Excellent Talents in University (No. NCET-08-0102).

### References

- [1] J. Marangos: *Nature* **397**, 559(1999).
- [2] L.V. Hau, S. E. Harris, Z. Dutton, C. H. Behroozi: *Nature* **397**, 594(1999).
- [3] H. Altug, J. Vuckovic: *Appl. Phys. Lett.* **86**, 111102-1(2005).
- [4] K. Y. Song, M. G. Herraiez, L.Thevenaz: *Opt. Exp.* **13**, 82(2005).
- [5] M. Niklès, L. Thévenaz, and Ph. Robert: *J. Lightwave Technol.* **15**, 1842(1997).
- [6] Y. Okawachi, M. S. Bigelow, J. E. Sharping, Z. M. Zhu, A. Schweinsberg, D. J. Gauthier, R. W. Boyd, A. L. Gaeta: *Phys. Rev. Lett.* **94**, 153902-1(2005).
- [7] A. Zadok, A. Eyal, M. Tur: *Opt. Exp.* **14**, 8498(2006).
- [8] Michael D. Stenner, Mark A. Neifeld, Zhaoming Zhu: *Opt. Exp.* **13**, 9995(2005).
- [9] Aldo Minardo, Romeo Bernini, Luigi Zeni: *Opt. Exp.* **14**, 5866(2006).
- [10] Miguel González Herráez: *Opt. Exp.* **14**, 1395(2006).
- [11] E. Shumakher, N. Orbach, A. Nevet: *Opt. Exp.* **14**, 5877(2006).
- [12] Th.Schneider, M.Junker, K.-U. Lauterbach: *Opt. Lett.* **32**, 220(2007).
- [13] Kwang Yong Song: *Opt. Exp.* **13**, 9758(2005).
- [14] Kwang-Yong Song, Kazuo Hotate: *Opt. Lett.* **32**, 217(2006).
- [15] Shihe Wang, Liyong Ren, Yu Liu, Yasuo Tomita: *Opt. Exp.* **16**, 8067(2008).
- [16] Kazi, S. Abedin: *Opt. Exp.* **13**, 10266 (2005).
- [17] Kazi, S. Abedin: *Opt. Exp.* **14**, 11766(2006).
- [18] C. Jáuregui, H. Ono, P. Petropoulos, D.J. Richardson: *Proc. OFC*, 2006, p.22
- [19] Ying Zhang, Pei-lin Lang and Ru Zhang: *Opt. Lett.* **5**, 135(2009).
- [20] Taiji Sakamoto, Takashi Yamamoto, Kazuyuki Shiraki, Toshio Kurashima: *Opt. Exp.* **16**, 8026(2008).
- [21] César Jáuregui, Periklis Petropoulos, David J. Richardson: *Opt. Exp.* **15**, 5126(2007).

---

\*Corresponding author: zhaoyong@ise.neu.edu.cn